

Investigation Report

Identification

Type of Occurrence:	Accident
Date:	4 October 2007
Location:	Düsseldorf
Aircraft:	Airplane
Manufacturer / Model:	Airbus / A330-322
Injuries to Persons:	None
Damage:	Aircraft severely damaged
Other Damage:	Minor damage to buildings and outdoor facilities
Information Source:	Investigation by BFU
State File Number:	BFU 1X002-07

Factual Information

History of the Flight

The airplane with 11 crew and 114 passengers aboard was on a flight from Düsseldorf, Germany, to Saloniki, Greece. At 1050¹ hrs in Flight Level (FL) 105 during climb the crew noticed a loud bang. Simultaneously, the aircraft began to yaw in combination with unusual sounds. The crew checked whether doors and hatches were

¹ All times local, unless otherwise stated

properly locked. A short time before the speed was increased from 250 kt to 350 kt. Since the Electronic Centralized Aircraft Monitor (ECAM) did not indicate any malfunctions the flight was continued. A short while later the cabin crew noticed that a large part of the left engine cowling was missing and reported it to the pilots.

The crew decided to abort the flight and return to Düsseldorf. They did not declare an emergency. The airplane landed in Düsseldorf without any further problems. At the parking position the fire brigade determined that the left wing leaked fuel.

Personnel Information

Both pilots held valid licenses and medical certificates. The Pilot in Command (PIC) had a total flying experience of about 9,500 hours, about 2,743 hours of which on the type. The copilot had a flying experience of about 7,500 hours, about 500 hours of which on the type.

Aircraft Information

The aircraft A330 is a twin-engine low-wing airplane. It has a seating capacity for 361 passengers. The aircraft had a German certificate of registration. At the time of the accident, total operating hours were 45,156. It has integral tanks in its wings.

Manufacturer:	Airbus
Year of manufacture:	1996
Engines:	Pratt & Whitney 4168
MTOM:	217,000 kg

One engine each is mounted to the underside of the right and left wing. Each engine is covered by a cowling. The fan cowling area consists of a front (fixed) and an aft section. The front part is connected with the air intake. The aft fan cowling doors open to the right and left for maintenance purposes. Both doors rotate upward about two hinges mounted to the forward upper pylon structure. Each cowling part is equipped with a telescope bar so that it can be propped open. Behind the cowling the thrust reverser is located.

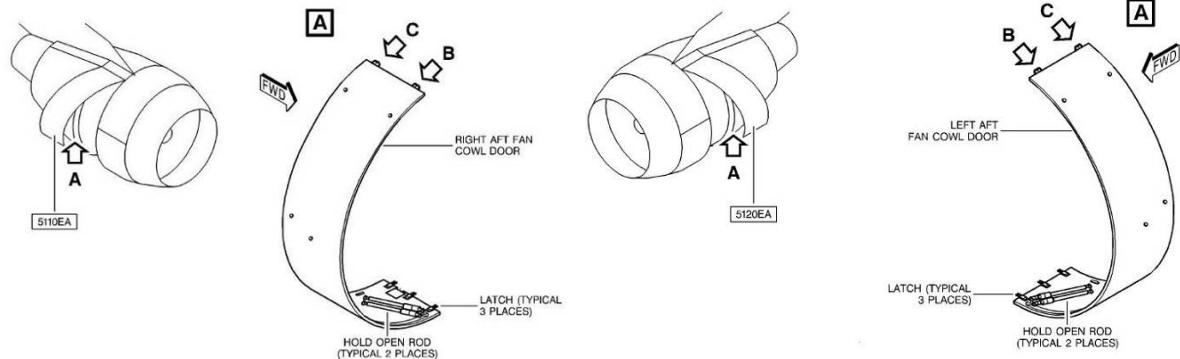

Right and left aft fan cowling

Source: Manufacturer

Both aft fan cowling doors are secured in the closed position by three latches at the bottom of the door panels. Each of the three latches consists of a latch hook within a housing assembly attached to the left door which engage an adjustable clevis within a keeper assembly attached to the right door. The hook is guided by several links and tightened with a handle. The correct alignment of hook and clevis is ensured by a shear pin on the keeper housing which engages a bushed receiving hole on the latch housing. In the closed position the handle is locked by two small hooks. Each cowling door is guided by axial locators. The distance between latches and ground is about 90 cm.

The A330 has three independent hydraulic systems, designated Blue, Green and Yellow.

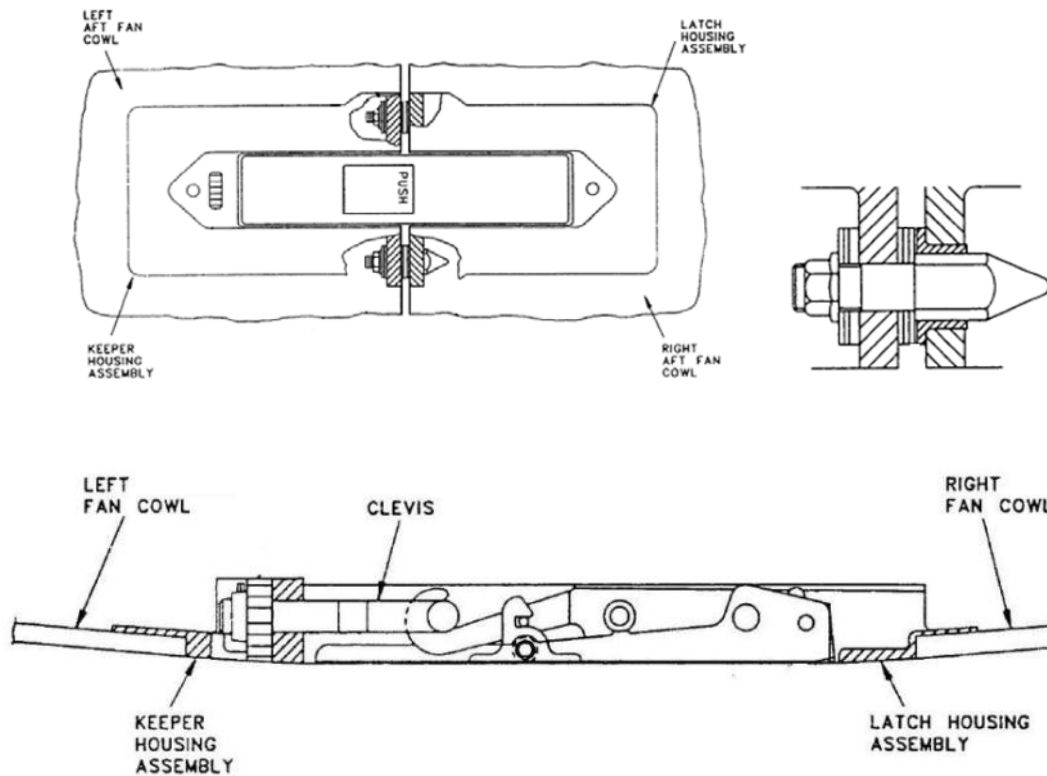

Drawings of the latches

Source: Pratt & Whitney

Meteorological Information

According to the aviation routine weather report (METAR) for Düsseldorf issued at 1050 hrs (08:50 UTC) the following weather conditions prevailed:

Wind velocity: 270° / 05 kt
 Visibility: 5,000 m / mist
 Clouds: 3-4 Oktas in 700 ft, 5-7 Oktas in 1,000 ft
 Temperature: 15 °C
 Dewpoint: 13 °C
 Air Pressure: 1,021 hPa

Communication

Radio communications with the responsible air traffic service providers were conducted in English. The transcripts were available for the investigation.

Aerodrome information

Düsseldorf Airport is an international airport. It has two parallel runways 050°/230°.

Flight Recorders

The airplane was equipped with a Flight Data Recorder (FDR) (L-3 Communications Corporation, F 1000) and a Cockpit Voice Recorder (CVR) (L-3 Communications Corporation, FA 2100). Both recorders were available for evaluation.

Wreckage and Impact Information

The loss of the two cowling doors occurred above Düsseldorf-Dormagen, in approximately FL 105. About 90% of the left cowling door and about 30% of the right were found on the ground.

Each of the two cowling doors had fractured directly below the hinges. The fragment of the right (inner) cowling door got jammed below the cowling. On the left (outer) door a front and an aft fragment were found. The aft fragment was jammed below the fixed cowling part. The front fragment was movable.



Residual fracture, right and left side



Photos (2): BFU

The airplane showed damages on the wing's lower surface. Fuel from the integral tanks leaked through two holes in the sheeting. Each hole had a diameter of about

8 mm. Other parts of the cowling had damaged the belly fairing. One of the telescope bars had penetrated the fairing. Once the belly fairing was removed, damages to the structure and hydraulic pipes were determined. Only lines of the blue system were affected which had the following functions:

- Blue system reservoir air pressurisation
- Return line engine #1 thrust reverser
- Engine Driven Pump (EDP) case drain line
- EDP suction line (blue system),

Furthermore, parts of the cowling latches were found in this zone.



Damages to the belly fairing



Photos (2): BFU

Additional damages were found on the slats, the flap fairing and on two passenger windows. A continuous scratch mark ran from the initial impact mark on the slats to the belly fairing.



Continuous scratch mark on the lower surface of the wing

Photo: BFU

The lower section of the cowling doors showed different damages. On the left door the front two keeper housings (A and B) did not show any damages or impact marks, the aft clevis (C) was torn out. On the left door the front hook (A) was severely damaged, the centre hook (B) was torn out and the aft hook was damaged. The pieces found on the ground and in the belly fairing, respectively, could be matched with latches A and B, respectively (Appendix 1). The outer edge (in the area of the engine centre line) of the left cowling door was straight and did not show any damages. The outer edge of the right cowling door, however, showed an arch-shaped deformation.

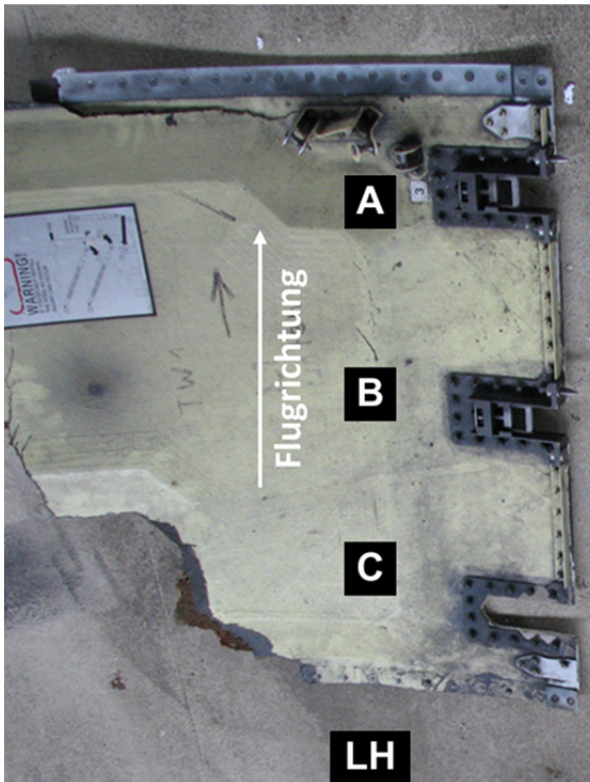

Damages to the latches

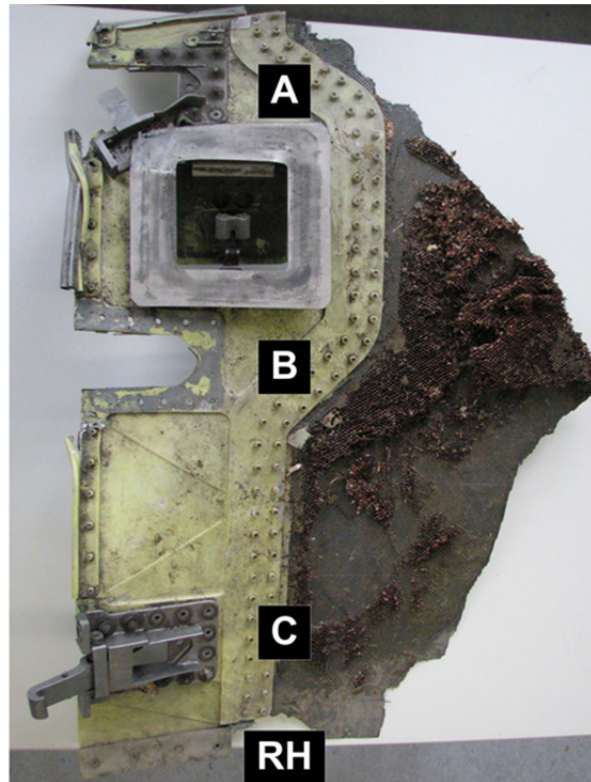

Photos (2): BFU

The latches showed the damages described in Appendix 2. The engine manufacturer, who was also responsible for the cowling, examined all latch parts as well. It was determined, among other things, that on the front hooks of latches A and B white paint residue was present which matched the paint of the cowling.

The receptacles (PN 73M603-001) were partially worn. Immediately after the accident they were replaced.

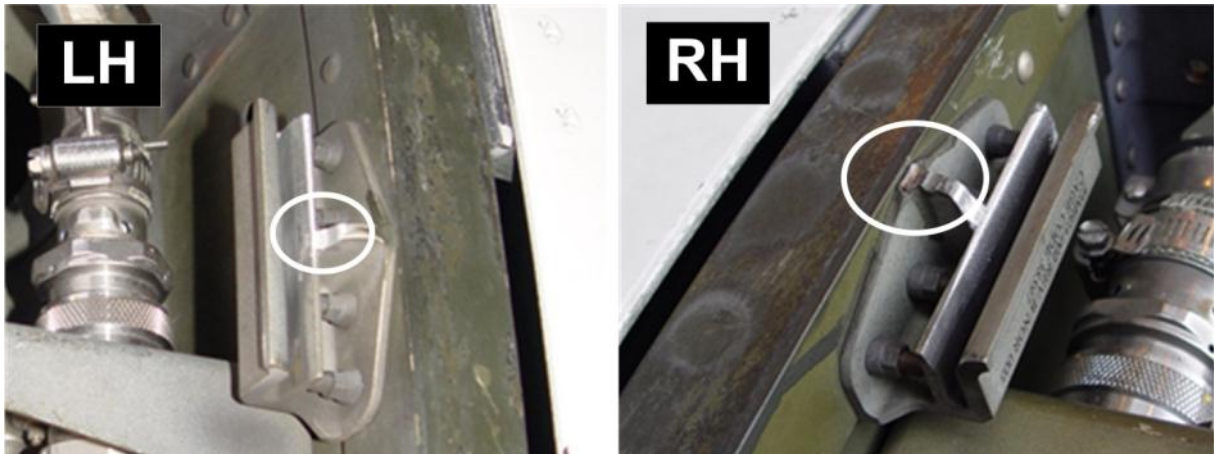

Wear on the receptacles for the axial locators

Photo: BFU

On the day of the accident and during the following days parts of the cowling were found in different places; some of these parts had caused damages to roofs and garden furniture.

Fire

There was no fire.

Tests and Research

The BFU conducted tests which should determine which different locking situations would be possible.

Both cowling doors are wide open at the engine centre line when the cowling is unlocked and open. When both cowling doors are brought together the hooks can be clasped into the opposing clevises. A gap of about 2 cm remains between the two cowling doors, however. In order to lock the latches they have to be engaged and locked in one motion. An interim position is not possible.

When the cowling was closed and the latches were opened again the latches remained in an engaged and half open position. It was also possible to release two hooks from the clevises and to leave the third (in this case the aft) in the clevis (braced). In both cases there was no gap between the cowling doors.

Additional tests showed that the two cowling doors can only be locked if the latches are in correct alignment. Only if the latches are completely incorrectly aligned it is possible to lock the cowling with a gap which is about 2 cm wide. Then the alignment

pins are not inserted into the opposing bushing. The latches could only be locked using great force.

It was also tested whether it is possible to position a cowling outside the receptacles (receptacle without wear). By doing so the cowling was pushed forward and backward. In any case the axial locator moved into the respective receptacle..

It was also tried to move one cowling door forward and backward, respectively, to connect it outside of the upper axial locator. It was not possible.



Closed and clasped cowling.



Closed cowling with one clasped latch (aft)
Photos (2): BFU

In addition, the engine manufacturer conducted tests to simulate the different locking variations of the cowling. It was determined that due to gravity normally the hooks clasp into the clevises on their own when the cowling doors are brought together. Thereby, the distance of the two doors was so great that the alignment pins did not necessarily align with the opposing receiving holes.

Tests were conducted to simulate the bearing of the axial locator on the worn receptacle. The range of axial locator and receptacle were limited. In this case the cowling could only be closed by applying a significant force. One or more latches were outside of the contour of the cowling.

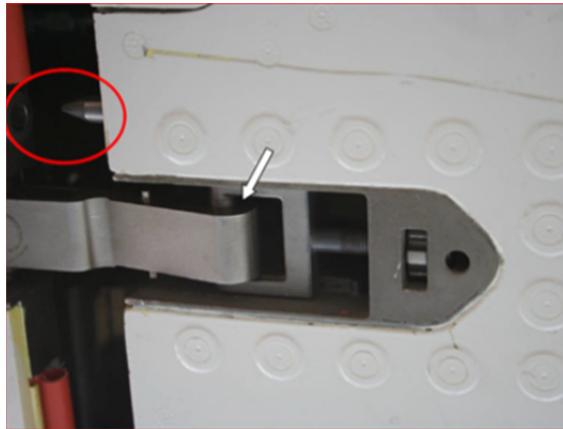

Locked hook / alignment pin unaligned

Photo: Pratt & Whitney

The Bundeswehr Research Institute for Materials, Explosives, Fuels and Lubricants (WIWEB) in Erding examined parts of the composite fairing. No conspicuous values were determined which would have caused the structural failure of the composite. Extensive pores and linear porosity were found which extended over several layers. It was stated that damages cannot be ruled out if water penetrates which then freezes.

The manufacturer examined the composite structure and determined 2% porosity.

Additional Information

1. During the night prior to the accident an A-check on the left engine was conducted. For this purpose the cowling had to be opened and later it had to be closed. In addition, an engine ground test was conducted. The ground test was recorded with the camera of a mobile phone. The quality of the recording did not allow an analysis. The mechanics involved stated they had closed the cowling correctly.
2. In January 2005 the right cowling door was overhauled due to crack development and then installed on the airplane. The place where the repair occurred was undamaged.
3. In the past, occurrences happened where cowlings had opened. For Airbus this mainly affected the A320 family (Refer to: Transportation Safety Board of Canada (TSB) Report Number A00O0199 and Airbus 14th Flight Safety Conference, among others). These documents state that all losses of cowling occurred after a maintenance action. They were caused by incorrectly locked cowling latches. Furthermore, Airbus released a Maintenance Briefing Note with the topic Human Perform-

mance/Error Management and an article with the topic Preventing Fan Cowl Door Loss (Safety First, Issue 14, July 2012), both in 2012. Analysis

1. Damages on the Latches

The deformation of the latch pin slots of latches A and B are about in the centre. Therefore, the deformation occurred with the hooks not in the locked position (red bolt); in the locked position the bolt would be at the outer end of the hook (green bolt). Since the deformation line does not run perpendicular to the longitudinal axis of the hook, the damage must have occurred when the hook was not locked otherwise the clevis and the bolt would have caused a perpendicular deformation.

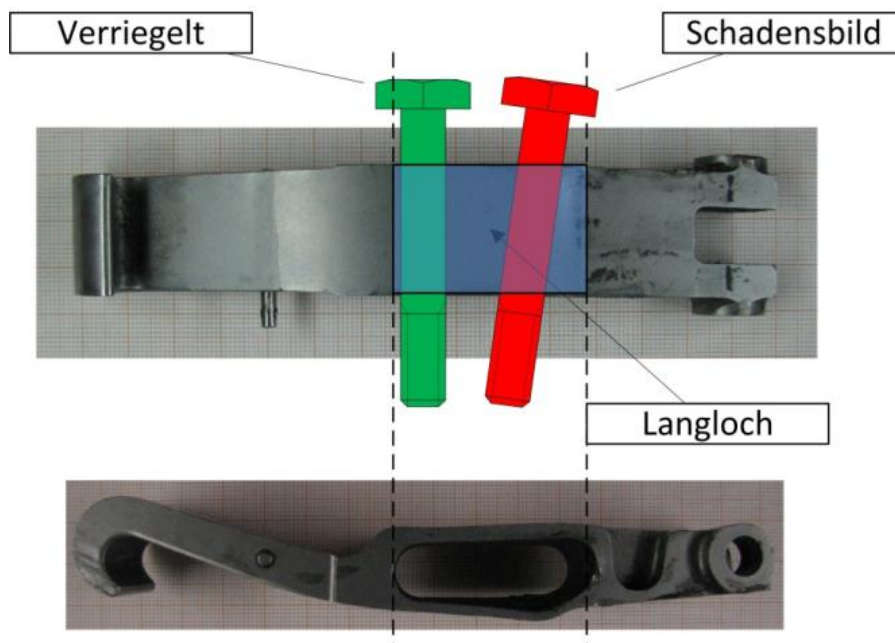

Position of the bolt in a locked latch versus the damage (latch A)

Foto (2): BFU

The position of the impact mark on the link (#3) also indicates that the hook and the handle of latch B were not closed when the damage occurred.



The approximate position of the link versus an undamaged latch

Source: BFU

The deformation of the aft flank of latch housing A, the indentation of the latch hook (#4) and the deflection of the bolt (#2) show that the hook was deflected by about 30° at the time. Geometrically it is not possible that at that time all latches were aligned because the left aft part of the cowling door would have overlapped with the right. Therefore, the conclusion can be drawn that the aft flanks of the latches were unlocked when the deflection occurred.

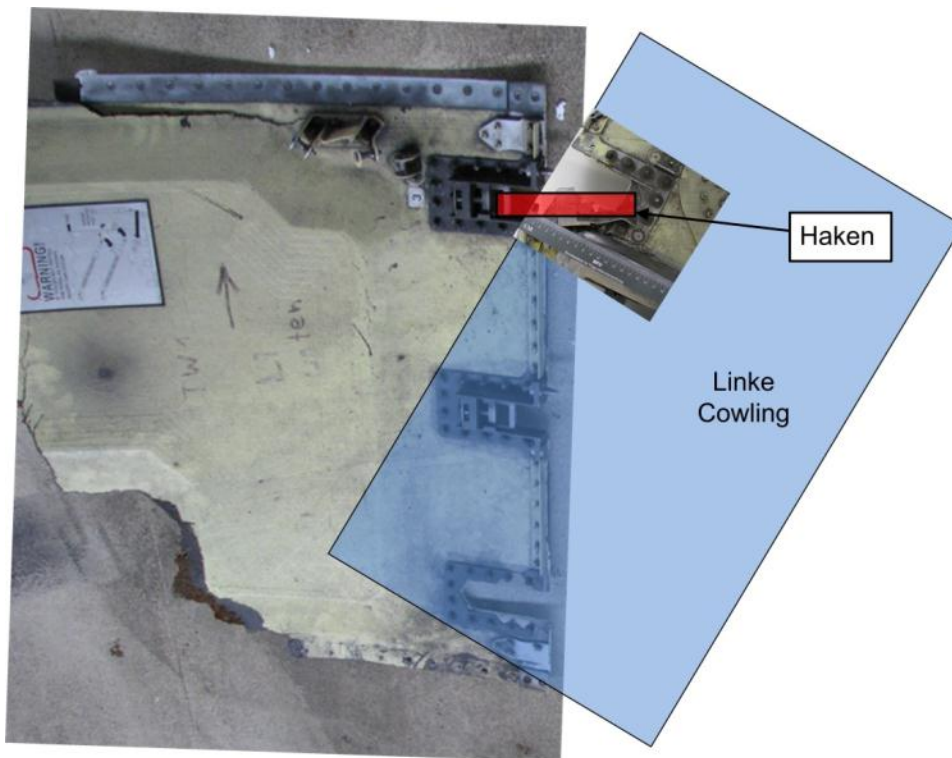

Position of the left cowling (if latch A was locked)

Source: BFU

The shear pin receiving holes of latches A and B showed an oval deformation; the deformation of the receiving hole for latch A was significantly more pronounced. It is highly likely that these deformations were not caused by the alignment pins because they do not show any marks or damages. The damage was caused by the latch assembly transferring the compressive stress to the receiving hole on impact. This is confirmed by the shear stress the manufacturer had determined in the fracture pattern of the latch housing.

The handle found separately (#5) could not be positively matched either with latch A or B. The undamaged locking hooks show that due to their design they were capable to lock the respective latch. Had the latch been locked correctly it could only be unlocked by pushing the unlocking area. This is not possible in flight.

The handle of latch C, on the other hand, is torn off in the unlocking area. In the locked position it extends over the contour of the cowling; since it was torn off at exactly that area it can be assumed that it was locked. This is also confirmed by the rupture line of the hook which is in the outer area.

In summary, the damages show that latches A and B were neither in the clasped nor the locked position when they were destroyed. It is highly likely that latch C was locked.

2. Damages on the Cowling Doors

The arch-shaped deformation on the outer edge of the right cowling door could not have occurred with a properly locked cowling latch otherwise a similar damage could be found on the left door. The left door, however, is mainly undamaged and straight. Due to this fact, the deformation has occurred as individual latches were not properly connected with the opposing part of the right cowling. The arch-shaped bends match the deformation of the cowling latches. Therefore, it is highly likely that the latches were peeled from the cowling one by one.

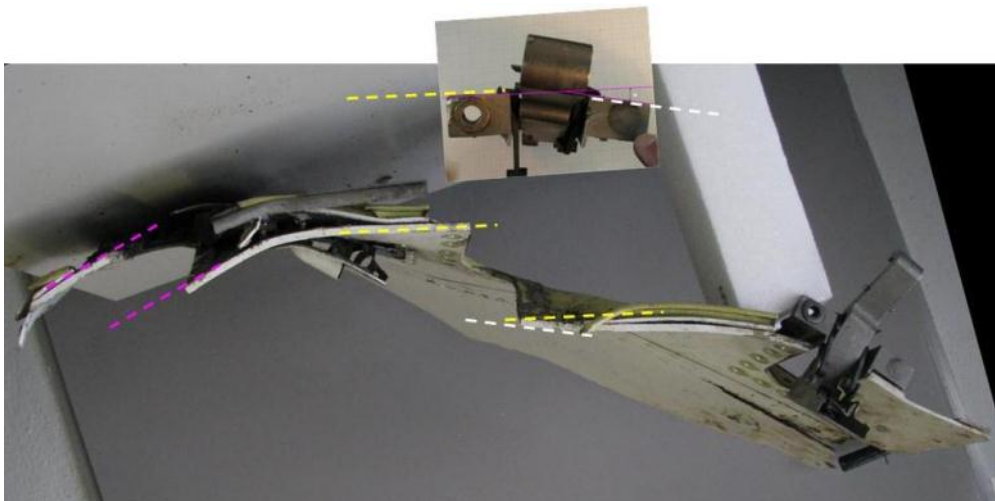

Arch-shaped deformation on the outer edge of the right cowling door

Source: BFU

3. Possible Damage Sequence

3.1 Incomplete Locking of the Latches

No traces, damages or other indications were found which show that the latches A and B were separated by force. The derivations in Sections 1. and 2. show that the damages can only occur if the latches are not aligned. The completely undamaged clevises A and B show that no force was applied to these latches. On the other hand,

the housing and the hooks of latches A and B were destroyed or deformed, respectively. This could only occur in the unlocked position.

The parts #1, #2 and #4 were either found on or in the belly fairing. It is, therefore, unlikely that they got there individually but on the same trajectory. Hence, they were still attached to the right cowling door. Once they hit the belly fairing, the latches interlocked with the fuselage and were then torn out of the cowling one after another. Since it is not possible to open the latches on the way from the engine to the belly fairing, they were not properly locked to begin with.

Latch C was either properly closed and locked or the hook had been engaged with the clevis. If the two housing assemblies would not have had a connection at all, the two cowling doors would have opened a lot sooner or the open position would have been noticed due to the large gap.

It is highly likely that at take-off the front and centre latches were not locked or already entirely open. Only the aft latch kept the two cowling doors together. Once air-speed was increased in Flight Level (FL) 100 and dynamic pressure increased, the aft clevis (C) was torn out of the structure. The right door was bent backward. A negative angle of attack was the result which bent the upper hinge mountings. Then the cowling door was torn off, hit the wing and its lower end impacted the belly fairing. This was confirmed by the impact marks on the wing and the long scratch mark on the belly fairing. The continued aerodynamic force tore off the latches interlocked with the fuselage. It can be assumed that the right door fractured into large pieces because otherwise the large aerodynamic force necessary to tear off the latches would not have occurred.

Already at an early stage, the left cowling door fractured into smaller pieces. This caused the different deformation in the area of the hinges.

3.2. Failure of the Upper Cowling Hinges

The upper cowling hinges did not fail because they were complete, fully functional and still attached to the engine pylon.

3.3. Structural Failure of the Cowling Doors

Had the left cowling door failed structurally, the remaining part and the left door would also have impacted the belly fairing. The parts could then behave in one of two ways.

A. Both doors remain connected with the latches until they impact the belly fairing. In this case the hooks would still be connected with the clevises. The hooks would not

have impacted the belly fairing individually. This does not correspond with the part distribution found on the belly fairing.

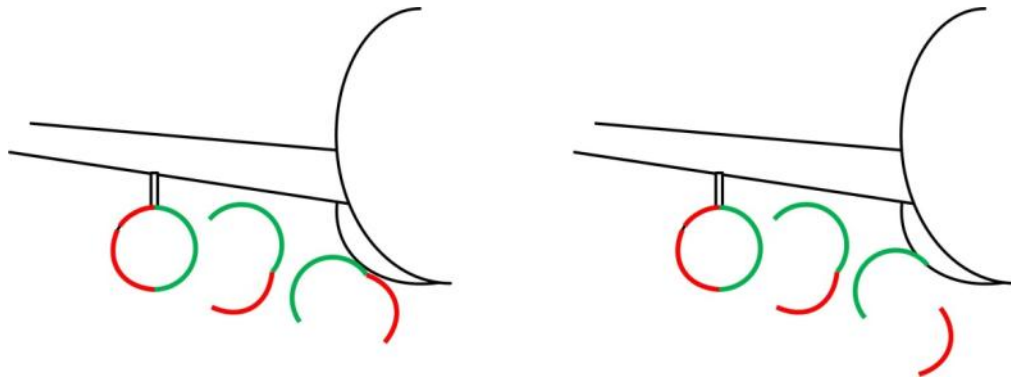

Possible movements of the cowling

left: 1. both doors remain connected

right: 2. both doors are separated at the latches

B. If, however, the latches had been destroyed corresponding traces due to interlocking and tearing would have been present. The described damages and traces on the latches do not confirm this. The left cowling door would also have shown damages on the keeper housings A and B.

Because no traces were found for either option, a structural failure of the doors can be ruled out. This was also confirmed by the examination the Bundeswehr Research Institute for Materials, Explosives, Fuels and Lubricants (WIWEB) did and which showed no conspicuous values which would have caused a structural failure.

3.4. External Factors

No traces were found which would suggest that external factors contributed to the accident.

3.5. Locking with Incorrect Aligned Cowling (Lateral Misalignment with the Axial Locator)

The outer area of the receptacle for the axial locator showed wear at the outer area. It could not be determined what caused the wear. If the wear had occurred with a locked cowling it would show that operation would still be possible without immediate damage to the cowling. The tests conducted by the BFU and the engine manufacturer show that locking the cowling is extremely difficult if receptacle and axial locator are not correctly aligned. The maintenance personnel stated, however, that they did not notice the need to increase force to lock the cowling.

The result of a misaligned axial locator is a gap between the cowling doors. With increasing airspeed the gap would cause a high stress on structure and latches. As a result the cowling would have fractured. This scenario (structural failure) was described in the Analysis under 3.3.A and ruled out as cause.

4. Conduct of Checks and Maintenance

The latches could have been in the following positions at take-off.

	A (Front)	B (Centre)	C (Aft)	Note
1	Open	Open	Open	a gap of about 2 cm
2	Open	Open	Clasped	a gap of about 2 cm
3	Open	Open	Locked	
4	Clasped	Clasped	Locked	
5	Clasped	Clasped	Braced	
6	Open	Open	Braced	
7	Braced	Braced	Braced	

A braced position of a latch can only be reached if a latch is locked and then released, therefore, cases 5, 6, and 7 can only occur if the cowling was closed before. Cases 1 and 2 are not very likely because a gap of about 2 cm would probably have been noticed. It could not be determined at which work step the latches were not properly locked.

Since the orange paint on the latch handles was not very visible it was easy to miss the incorrect locking condition of the latch. This could have been the reason why the crew also missed the incorrect locking condition.

5. Risks to the Airplane

The leaking fuel did not constitute a fire hazard during the flight, because there was no ignition source. On the ground the fuel could have come into contact with the hot brakes which could have posed as ignition source.

The destruction of the lines inside the belly fairing would lead to a failure of the blue system. The safe operation of the aircraft is assured by hydraulic system redundancy.

Conclusions

The accident occurred because the front and centre latch or all three latches were not properly locked.

That the alarm colour on the handles was worn contributed to the accident.

There is no indication of a structural failure of the composite fairing.

Investigator in charge: Karge

Assistance: Nehmsch

Braunschweig: 1 November 2012

Appendices

1. List of the Latch Parts Found (#1 to #6)

#1	#2	#3
		
Latch B Location: Belly Fairing	Latch housing Part of latch A Location: Belly Fairing	Link P/N: 119731-3 Location: Dormagen
#4	#5	#6
		
Hook, P/N 119725-1 Part of latch #A Location: Belly Fairing	Handle, P/N 119727-3 Location: Dormagen	Bushing, P/N 118720-1 Matched with find #2 Part of latch A Location: Dormagen

2. Description of the Distinctive Damages and Markings on the Found Parts

Latch A:

The aft flange of the housing was torn out and bent backward by about 30°. A dent was found (about 70 mm from the outer end).



Latch housing part #2 (part of latch A):

The bolt was bent by about 30°. The thread end was twisted by about 30° (about parallel to the screw head). The receiving hole of the bushing was torn and showed an oval-shaped deformation.



Link #3

The link showed a line-shaped impact mark which was slanted by about 30° in relation to the longitudinal axis

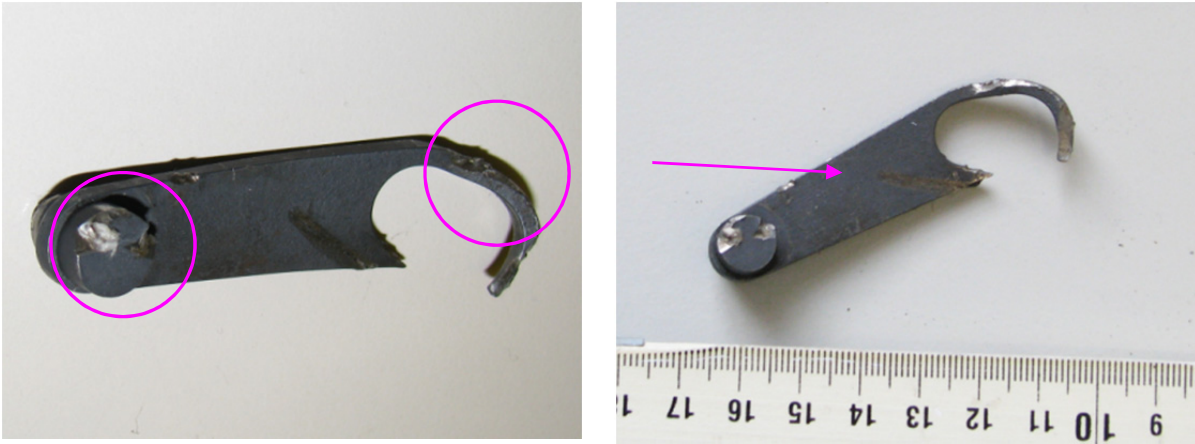

Hook #4 (part of latch A):

The hook showed a line-shaped deformation which was more pronounced at the front end. The line did not run perpendicular to the longitudinal axis of the hook (deviation about 7°). The housing of the hook was twisted. White paint residue was found on the front end.

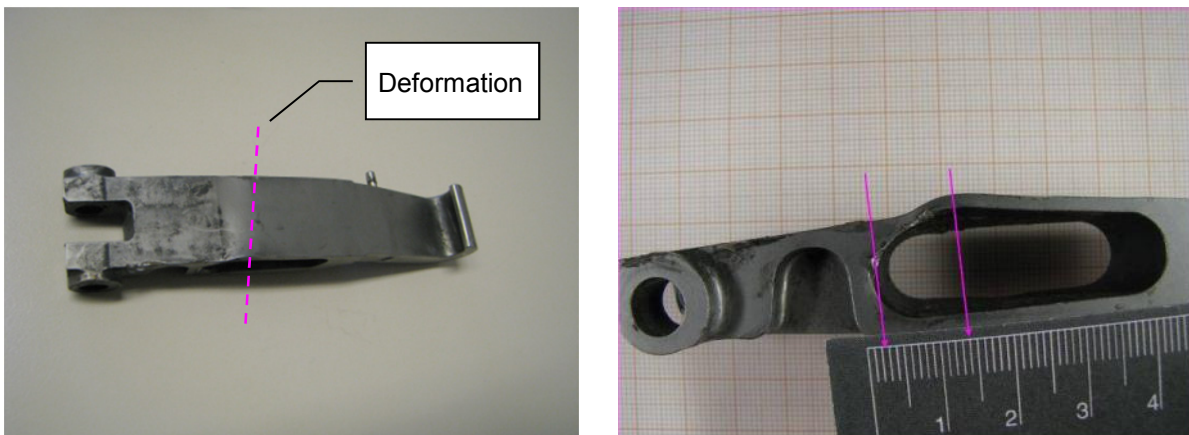

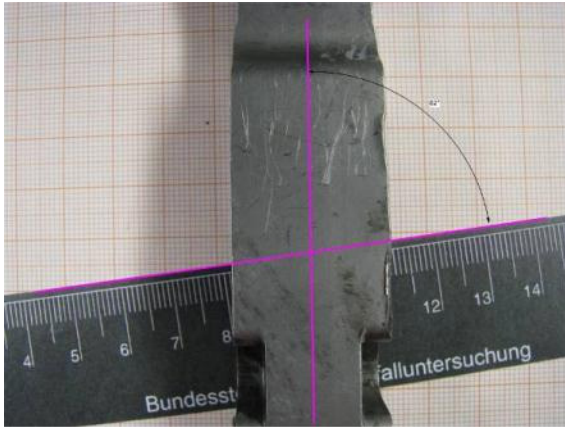

Shear Pin Receiving Bushing #6 (part of latch A):

The bushing showed an oval-shaped deformation and fit into the similar shaped receiving hole of housing #2.



Handle #5:

The handle was slightly twisted and one of the aft receiving holes was torn. The two locking hooks were undamaged. The orange alarm colour was worn and covered by grime. It could not be unambiguously matched with latch A or B.



Latch B

The housing was twisted. The hook showed a line-shaped deformation which was more pronounced at the front end. The line did not run perpendicular to the longitudinal axis of the hook. The bushing showed an oval deformation on its inner end.

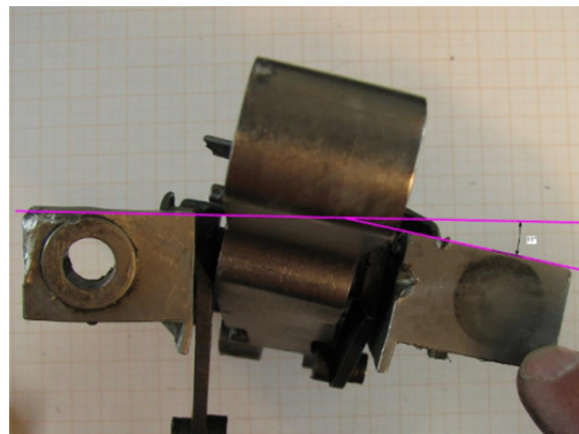
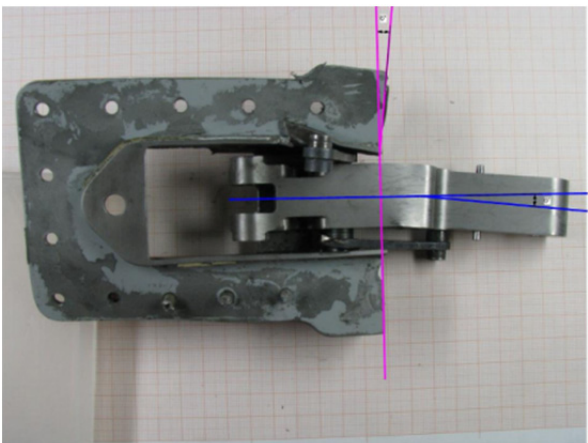
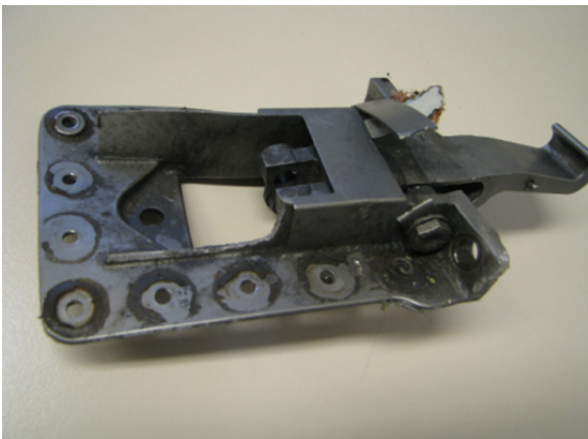

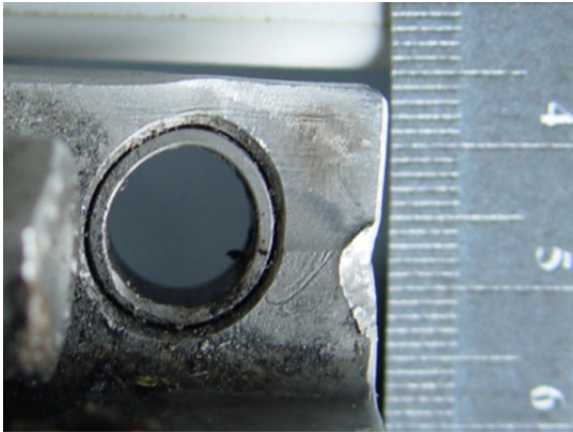

Latch C

The housing was not twisted. The hook of the latch was bent backward and had fractured in a straight line. The handle was fractured and both locking hooks were torn off.



Keeper housing assembly A

The keeper housing assembly did not show any visible damage.

Keeper housing assembly B

The keeper housing assembly did not show any visible damage.

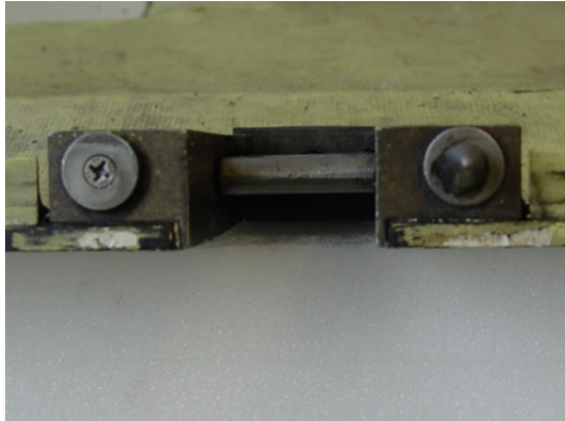

Keeper housing assembly C

The keeper housing assembly in the area of the mounting flange was destroyed.



3. Definitions

Open: The latch handle secondary trigger hooks are released from the safety crosspins, and the latch hook is not engaged with the clevis.

Clasped: The latch hook is engaged with the clevis but not in the over-centre position. The latch handle secondary trigger hooks are not secured to the safety crosspins.

Braced: The latch hook is engaged with the clevis and is in the over-centre position. The latch handle secondary trigger hooks are not secured to the safety crosspins.

Locked: The latch hook is engaged with the clevis and the secondary trigger hooks are engaged with the safety crosspins. The latching mechanism is properly prepared for flight.

This investigation was conducted in accordance with the regulation (EU) No. 996/2010 of the European Parliament and of the Council of 20 October 2010 on the investigation and prevention of accidents and incidents in civil aviation and the Federal German Law relating to the investigation of accidents and incidents associated with the operation of civil aircraft (*Flugunfall-Untersuchungs-Gesetz - FIUUG*) of 26 August 1998.

The sole objective of the investigation is to prevent future accidents and incidents. The investigation does not seek to ascertain blame or apportion legal liability for any claims that may arise.

This document is a translation of the German Investigation Report. Although every effort was made for the translation to be accurate, in the event of any discrepancies the original German document is the authentic version.

Published by:

Bundesstelle für
Flugunfalluntersuchung
Hermann-Blenk-Str. 16
38108 Braunschweig

Phone +49 531 35 48 - 0
FAX +49 531 35 48 - 246

Mail box@bfu-web.de
Internet www.bfu-web.de